

# CURRENT TRANSFORMERS

## Model 5

Window Diameter 1.56"

**APPLICATION:**  
With ammeters, wattmeters, and cross current compensation.

**FREQUENCY:**  
50-400 Hz.

**INSULATION LEVEL:**  
600 Volts, 10 kV BIL full wave.

- Flexible leads are UL 1015 105 ° C, CSA approved, #16 AWG, 24" long.
- Non-standard length to be specified.
- Terminals are brass studs No. 8-32 UNC with one flat washer, lockwasher and regular nut.
- SHT and SFT case styles also available as SHL and SFL with leads.
- Mounting bracket kit 0221B00180 when required for Model 5SHT.
- Approximate weight: 1.0 lb.

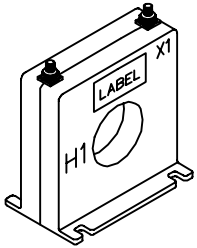

**5SFT**

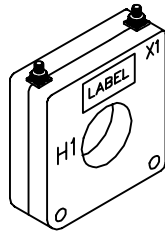

**5SHT**

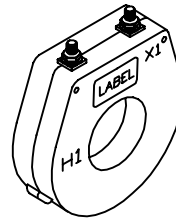

**5RT**

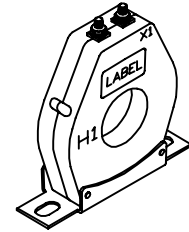

**5RBT**

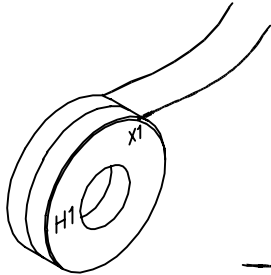
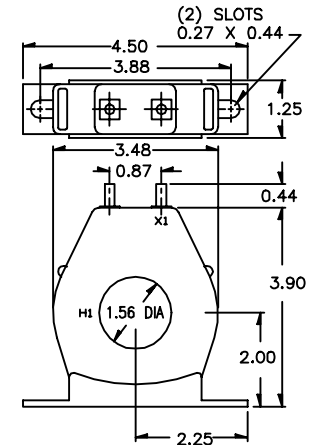
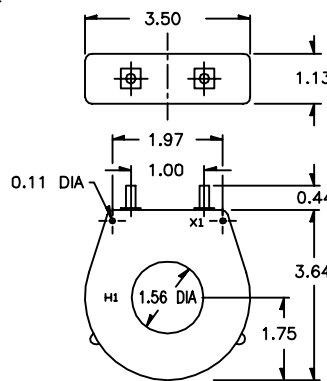
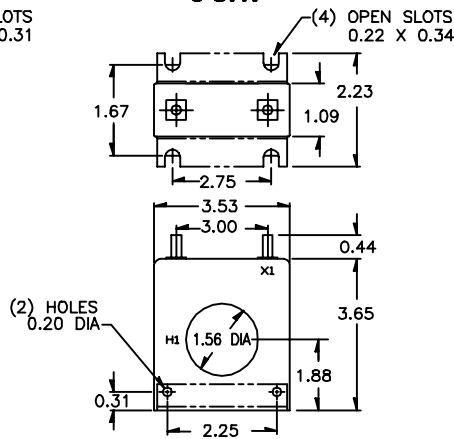
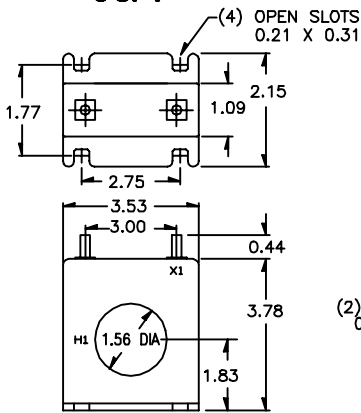

**5RL**

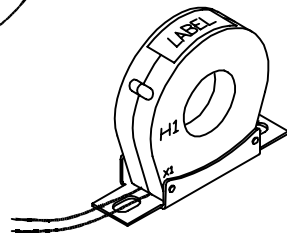

**5RBL**

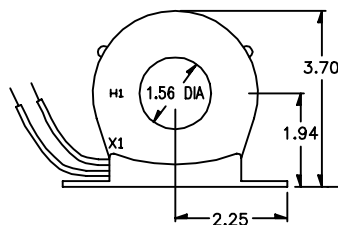
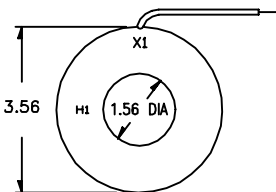
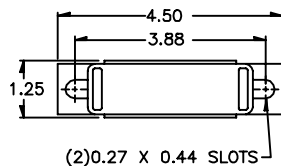
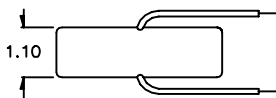

CATALOG NUMBER	CURRENT RATIO	ACCURACY AT 60 Hz	BURDEN VA at 60 Hz
5 **- 500	50:5	± 2 %	1.0
5 **- 750	75:5	± 2 %	1.5
5 **- 101	100:5	± 2 %	2.0
5 **- 151	150:5	± 1 %	5.0
5 **- 201	200:5	± 1 %	5.0
5 **- 251	250:5	± 1 %	10.0
5 **- 301	300:5	± 1 %	12.5
5 **- 401	400:5	± 1 %	12.5
5 **- 501	500:5	± 1 %	20.0
5 **- 601	600:5	± 1 %	25.0
* 5 **- 751	750:5	± 1 %	25.0
* 5 **- 801	800:5	± 1 %	25.0
* 5 **- 102	1000:5	± 1 %	25.0
* 5 **- 122	1200:5	± 1 %	30.0

\*\* NOTE: When ordering, prefix Cat No. with model designation required, i.e. 5SFT-500, 5RL-500, etc.

\* NOTE: Available in SFT, SHT and RL only.